

MASTERBAND

Product range

Hinge systems for front doors
visible and concealed installation





MASTERBAND

Product range

When it comes to concealed hinge technology, why stop at house and apartment front doors?

A visible, three-dimensionally adjustable hinge solution for rebated front doors is something our customers have often asked us for. After including single pivot hinges and strap hinges for doors and windows in our range for many years already, the evolution to the adjustable version was a logical step. As a result of this development we now present the **MASTERBAND 120 3-D CS**, whose slim construction ensures it is unobtrusive with respect to the exterior door design while still providing acceptable load-bearing capacity and a convenient adjustment facility.

The **MASTERBAND FX2 120 3-D CS** is an adaptation of **BaSys**'s concealed hinge technology, proven 1,000 times over, to the new application with the addition of further features, particularly in terms of the tightness of the hinge. Wing seals are accommodated by the hinge, and in the hinge itself there is also a seal to ensure the necessary tightness of house and apartment front doors.

These new models integrate seamlessly with the existing hinge solutions for this area and thus perfectly complement our new **MASTERBAND** product range - hinges for exterior doors and windows.

Finish

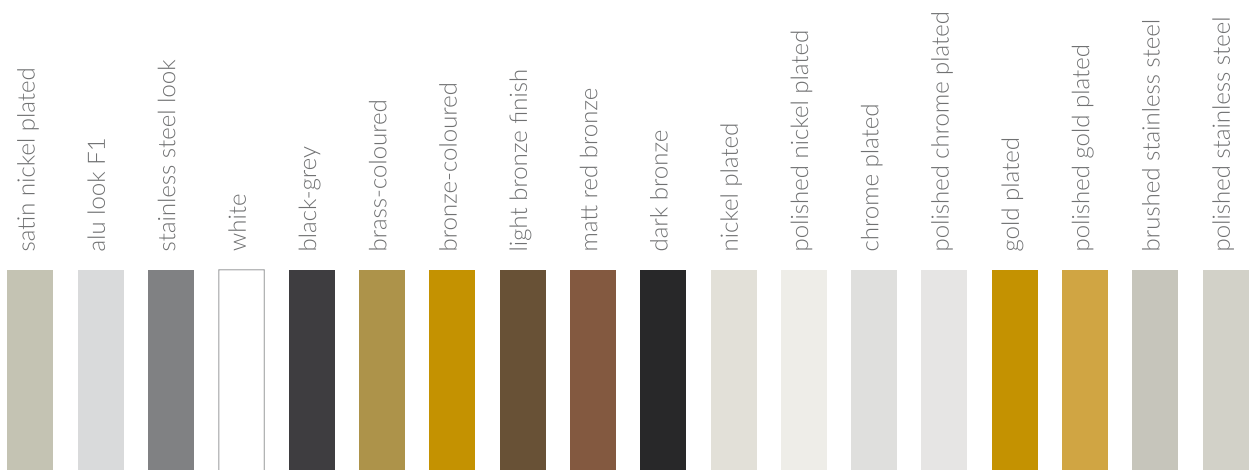



Installation

Easy and secure

The **MASTERBAND** is first inserted into the recess in the door wing and screwed in with standard screws.



Once the hinge has been screwed into the wing, the wing seal is fitted. This is accommodated within the hinge with the aid of the sealing groove and continues in the joint area in the form of a seal specific to the hinge.



The door leaf is connected to the frame. Now, the hinges are inserted into the frame recess. An assembly dolly can serve as an aid or assembly cushions, wedges, etc. can be used.

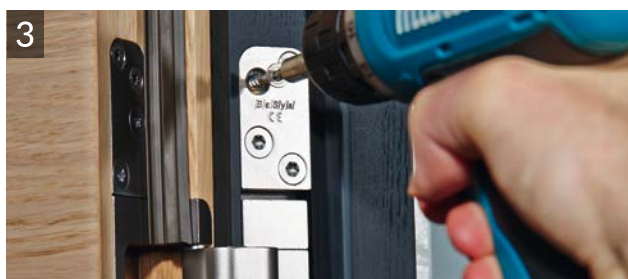

The inserted **MASTERBAND** FX2 120 3-D CS is screwed into the frame with standard screws. Mounting of the door element is now complete.

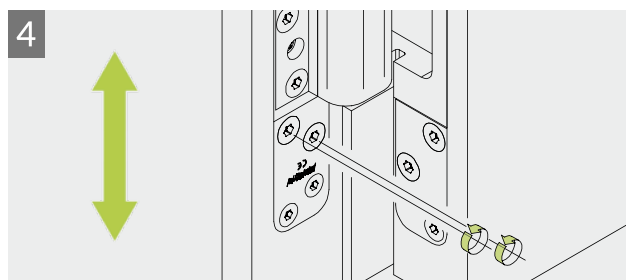

Height: slacken off the adjusting screws in the frame part. The hinge can now be moved 3 mm upwards or downwards. When the height is correct, tighten the adjusting screws slightly so that the teeth in the hinge engage.

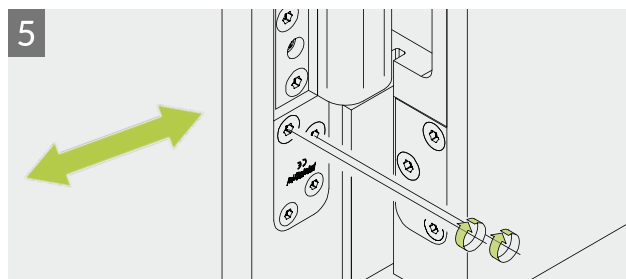

Seal contact pressure: push the hinge in the required direction (+/- 1 mm); the teeth will hold the door leaf at the correct height. Fully tighten the adjusting screws in the frame part of the hinge.

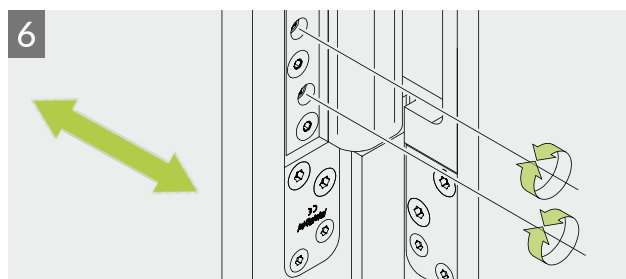

Joint clearance at the side: turn the adjusting spindles in the frame part of the **MASTERBAND** FX2 120 3-D CS to achieve exact positioning of the door leaf. The adjustment range is +/- 3 mm.



MASTERBAND

FX2 120 3-D CS

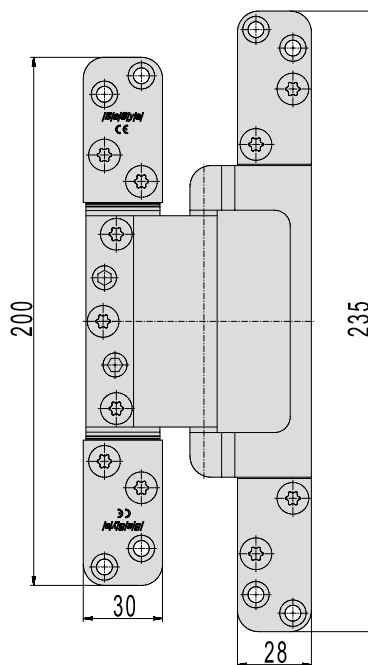

Maintenance-free design

3-dimensionally adjustable

Height: +/- 3 mm

Side: +/- 3 mm

Seal contact pressure: + 2 mm

Load-bearing capacity: 120 kg per pair

Application: rebated exterior doors
with wing seal up to 120 kg

Max. opening angle: 180°

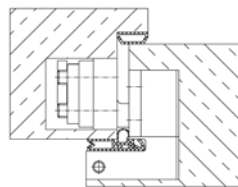
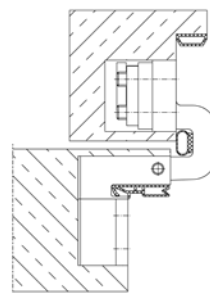

Photographer: Daniel Vieser, Architekturfotografie

MASTERBAND

120 3-D CS

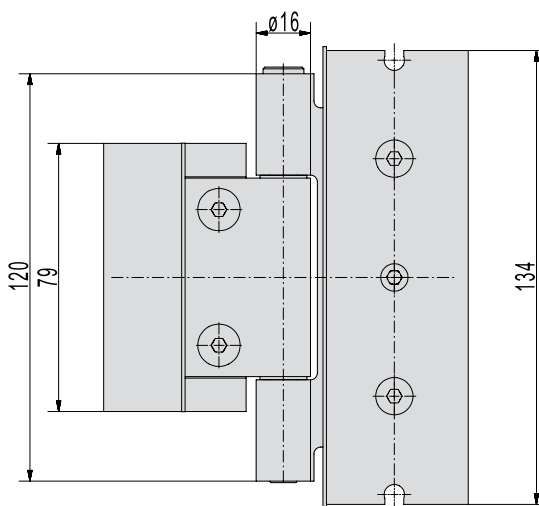

Maintenance-free design

3-dimensionally adjustable

Height: +/- 3 mm

Side: +/- 2 mm

Seal contact pressure: + 3 mm

Load-bearing capacity: 120 kg per pair

Application: rebated exterior doors with wing seal up to 150 kg (3 hinges per door)

Knuckle diameter: 16 mm

Pin lock as standard option

Adjustment via convenient eccentric technology

Decorative heads optionally available

Complementary single pivot and strips hinges available in the same look

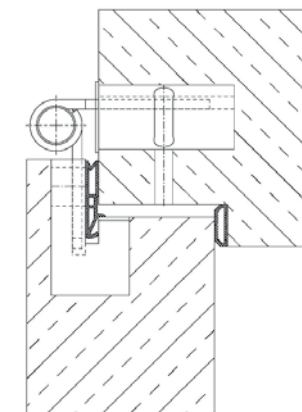



Single pivot window hinge
74 MF DH66



Standard load: door weight 80 kg (per pair)

Application: three-part single pivot hinge for rebated wooden windows, maintenance-free, with pin lock

Decorative head version possible on request

Other surface finishes possible on request

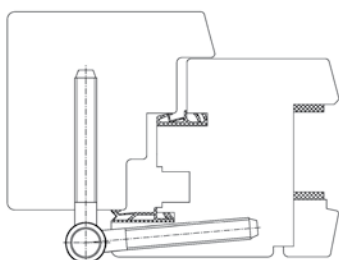

Hinge
80 MF DH66 (V4A)



Standard load: door weight 80 kg (per pair)

Application: three-part hinge for flush wooden doors or windows with wing seal, maintenance-free, with pin lock

Decorative head version possible on request

Other surface finishes possible on request

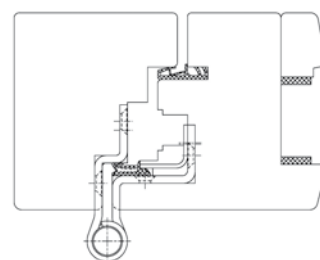



Photographer: Daniel Vieser, Architekturfotografie

Single pivot door hinge 120 MF DH66



Standard load: door weight 120 kg (per pair)

Application: three-part single pivot hinge for rebated wooden doors, maintenance-free, with pin lock

Decorative head version possible on request

Other surface finishes possible on request

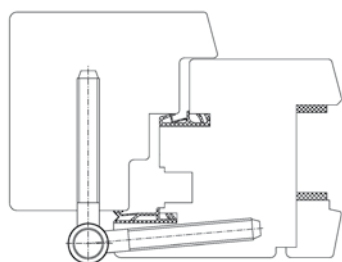

Single pivot hinge 120 MF DH66 (V4A)

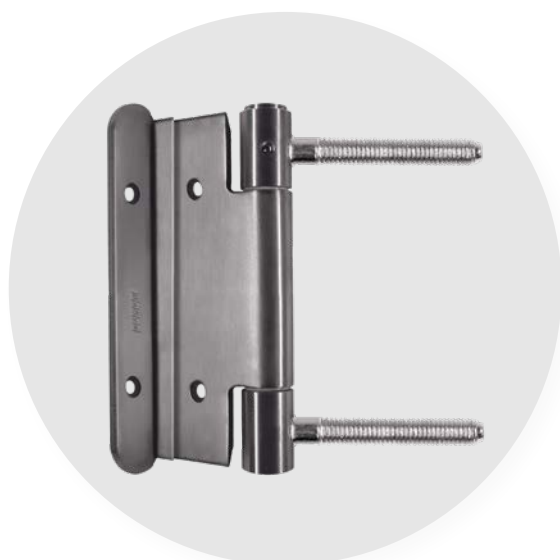

Standard load: door weight 120 kg (per pair)

Application: three-part hinge for rebated wooden doors with wing seal, maintenance-free, with pin lock

Decorative head version possible on request

Other surface finishes possible on request

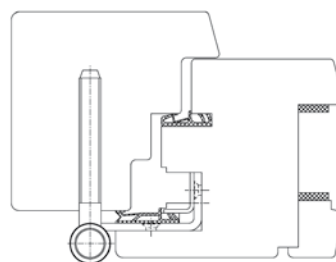



BaSys product world

From a single source

Made in Germany

Under this brand name we develop, produce and market the complete fittings range for well-known manufacturers in the German and European door and frame industry, as well as for international trade and industry customers. Alongside this main focus, our product range is

complemented by high quality furniture fittings and specially developed functional hinges, including for anti-burglary, fire protection and noise insulation applications.

PIVOTA® – Concealed hinge systems

OBJECTA® – Hinge systems for commercial property doors

STABILO® – Striking-plate systems

COMBICA® – Hinge systems for apartment doors

MASTERBAND – Hinge systems for front doors



B|a|S|y|s|
Bartels Systembeschläge GmbH

FITTINGS WITH IDEAS

Bartels Systembeschläge GmbH

Gewerbegebiet Echternhagen 2
32689 Kalletal

Tel.: +49 (0) 5264 6473-0

Fax: +49 (0) 5264 6473-30

vertrieb@basys.biz

www.basys.biz